

rasoline 55s_

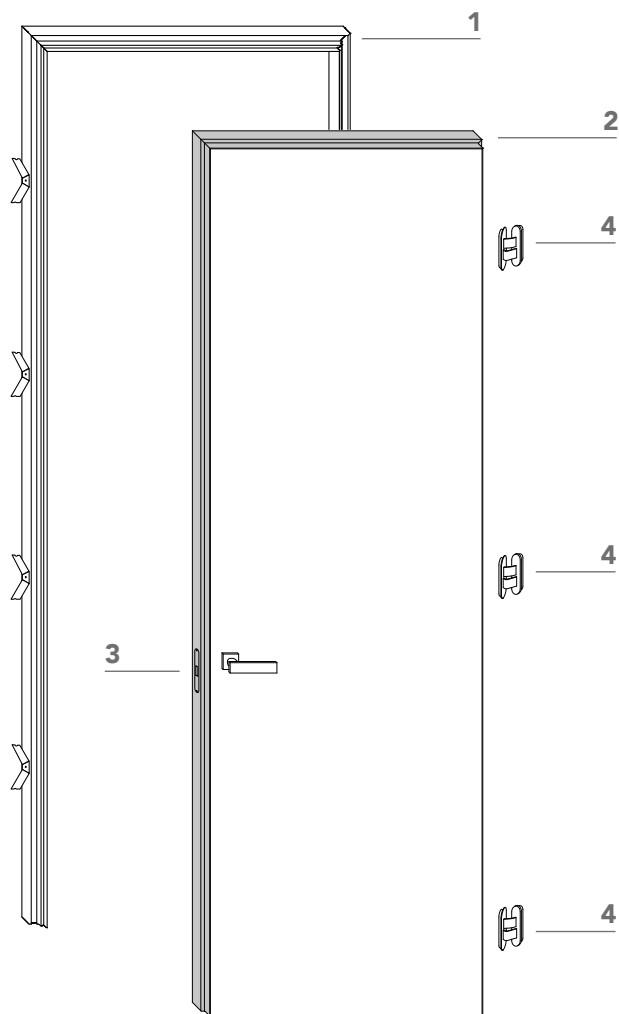

1 telaio in alluminio anodizzato preassemblato da murare senza falso telaio;

anodized aluminum frame to be installed without any subframe;

2 anta di spessore 55 mm in legno a struttura tamburata e bordo alluminio. Completa di serratura magnetica (3), cerniere a scomparsa regolabili sui tre assi (4) e guarnizioni di battuta antirumore (5).

swing wood door, with aluminum edge, 55 mm thickness. Hardware included: magnetic lockset (3), concealed hinges (4), anti-noise gasket (5).

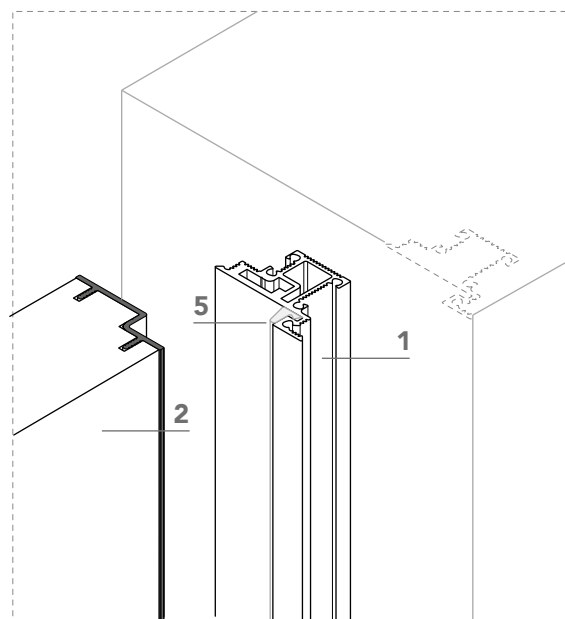
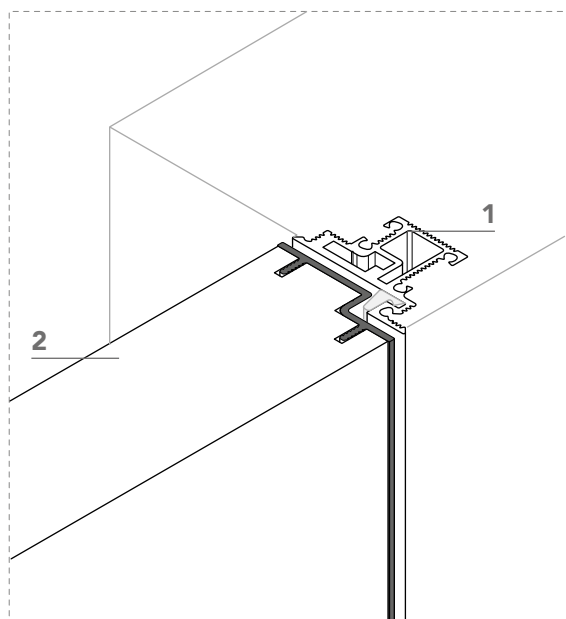

rasoline 55s_

sezione verticale - vertical section

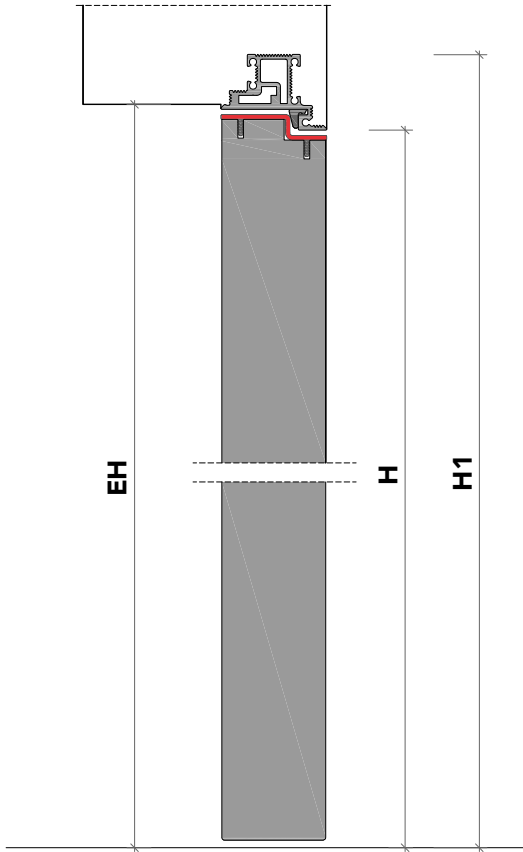

misure nette | **L** = luce / width
 net opening | **H** = altezza / height

vano muro | **L1** = L + 100 mm
 rough opening | **H1** = H + 50 mm

ingombro totale | **EL** = L + 28 mm
 overall sizes | **EH** = H + 14 mm

sezione orizzontale - horizontal section

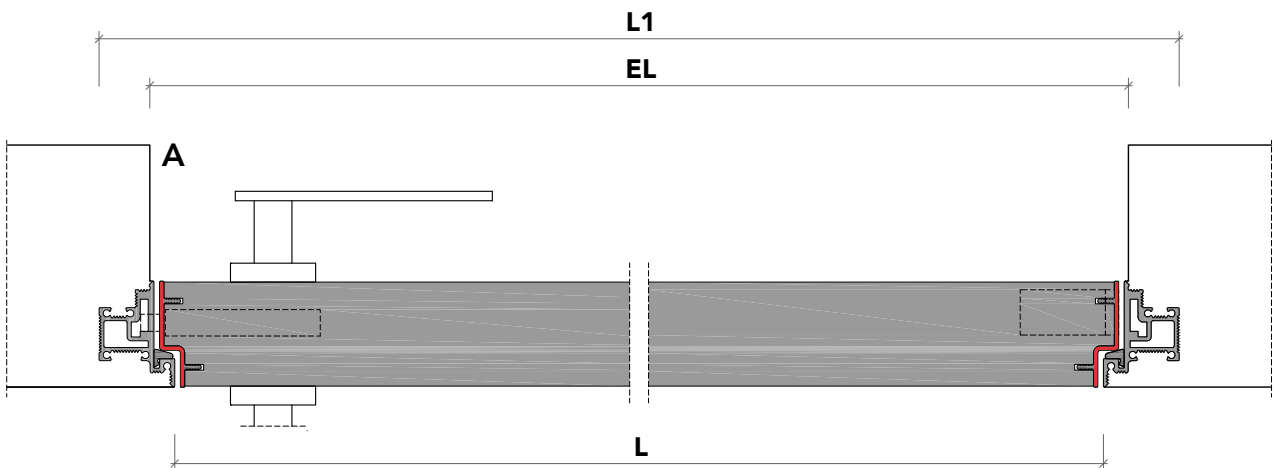

riduzione spessore per rivestimenti (max 4 mm) - thickness reduction for cladding (up to 4 mm)

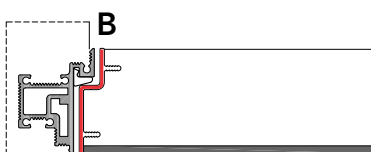

lato tirare - pull side

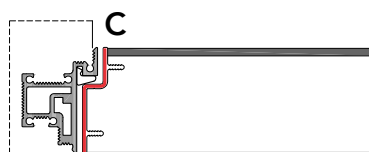

lato spingere - push side



entrambi i lati - both side

rasoline 55s_

telaio - frame

cartongesso - drywall

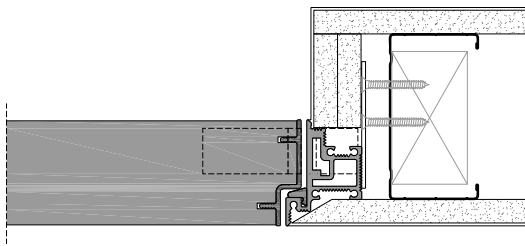

muratura - brickwall

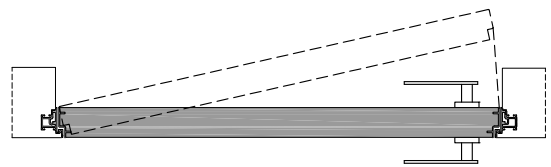
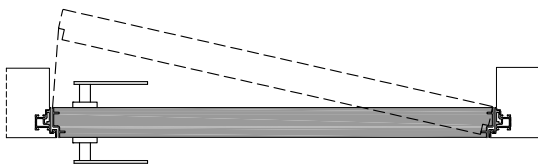
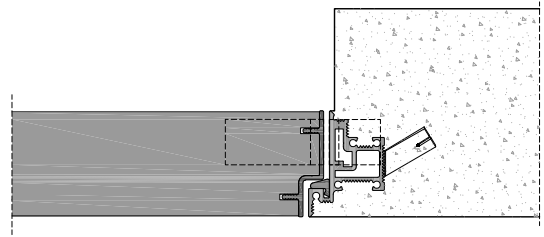

spingere destra - push right

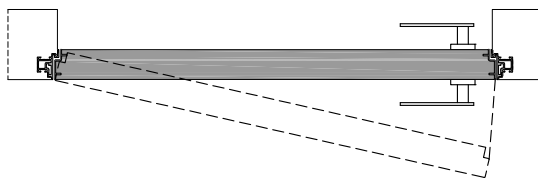

spingere sinistra - push left

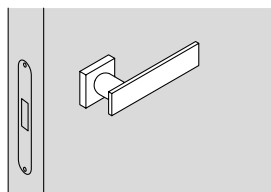
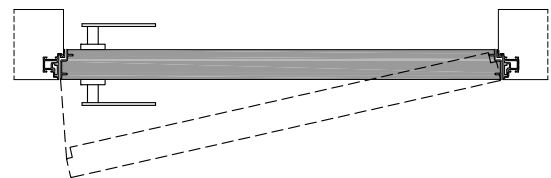

solo maniglia
only passage

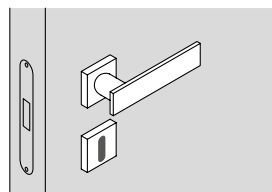

maniglia e chiave
handle and key

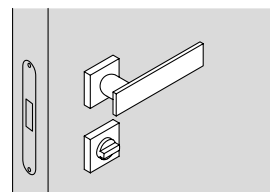

maniglia e nottolino
handle and privacy

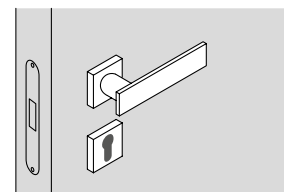

maniglia e cilindro di sicurezza
handle and security cylinder