

wall&door 55_

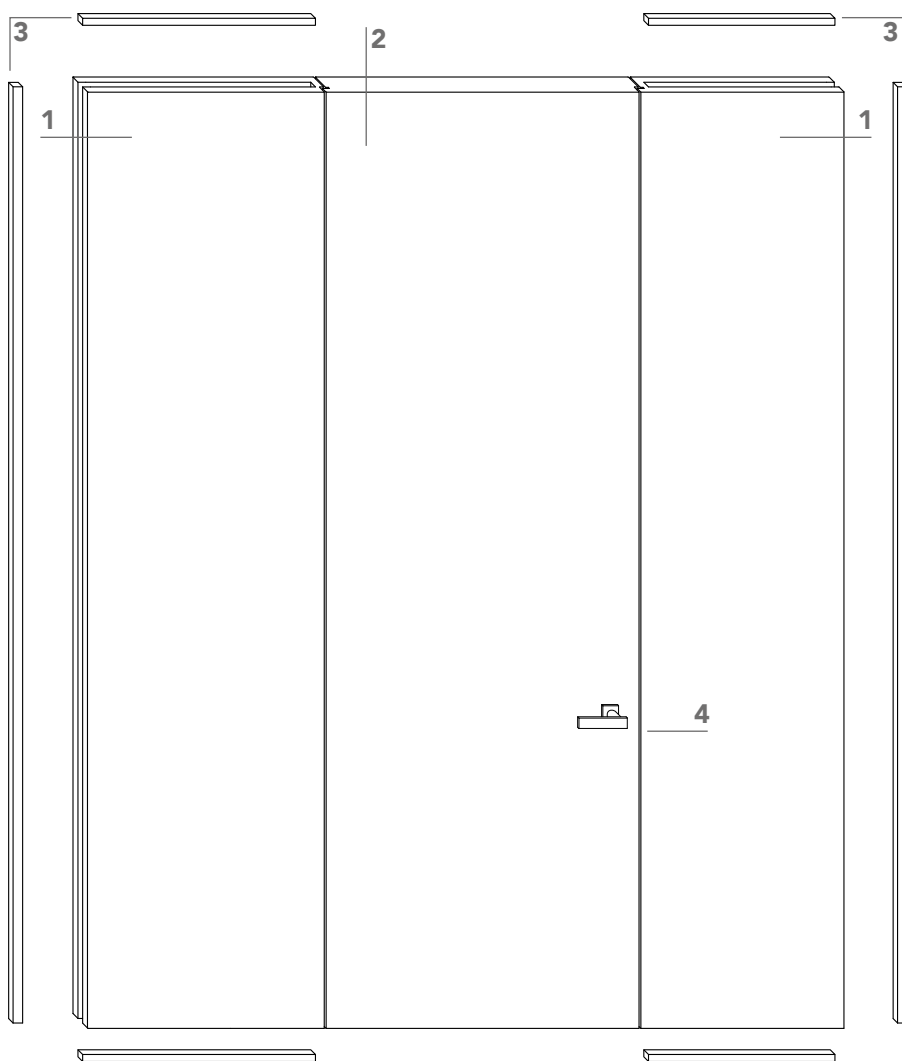

1 pannello fisso di spessore 55 mm;
55 mm thick fixed panel;

2 anta a bilico o a battente di spessore 55 mm in legno con struttura tamburata. Completa di serratura magnetica (4), cerniere a scomparsa, e guarnizione di battuta antirumore (5);
wood pivoting or swing door, 55 mm thick. Available in various configurations. Hardware included: magnetic lockset (4), concealed hinges, anti-noise gasket (5);

3 sistema di ancoraggio in legno.
wood fastening.

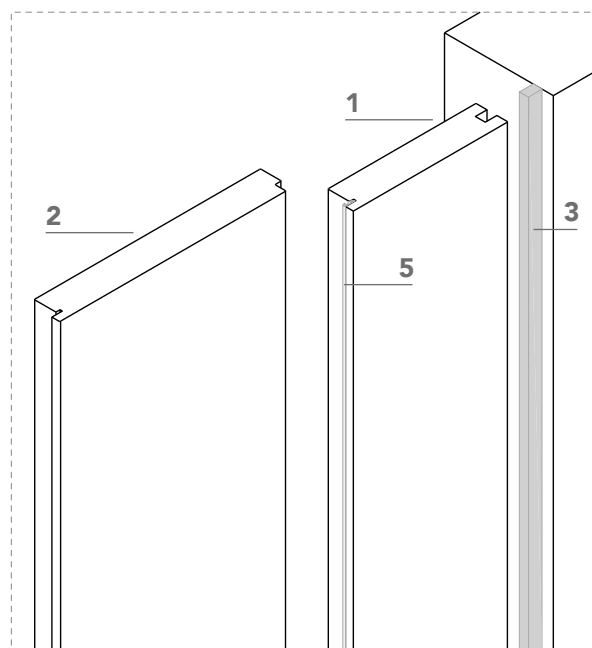
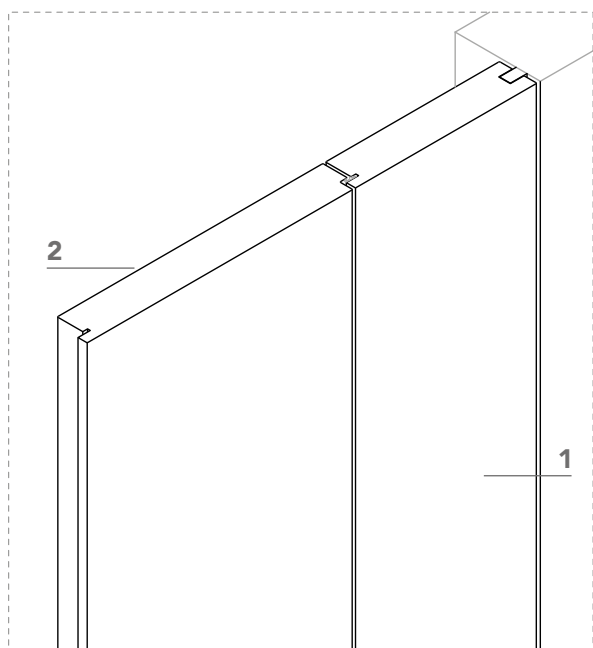

wall&door 55_

sezione verticale ■ vertical section

pannello fisso ■ fixed panel

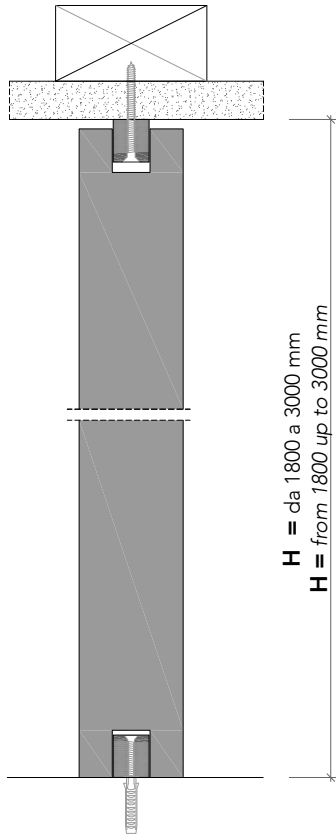

pannello a bilico ■ pivoting panel

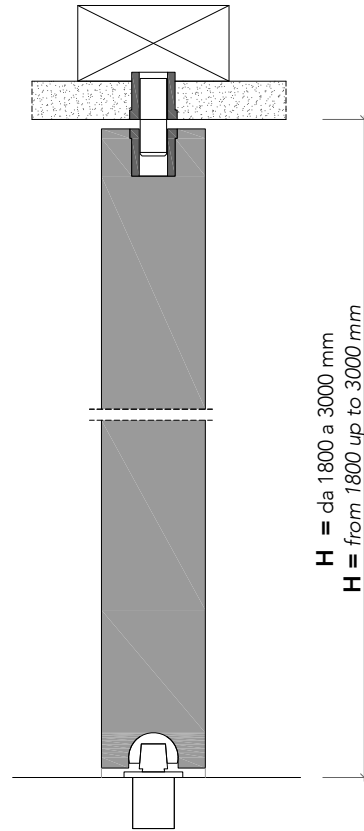

pannello a battente ■ swing panel

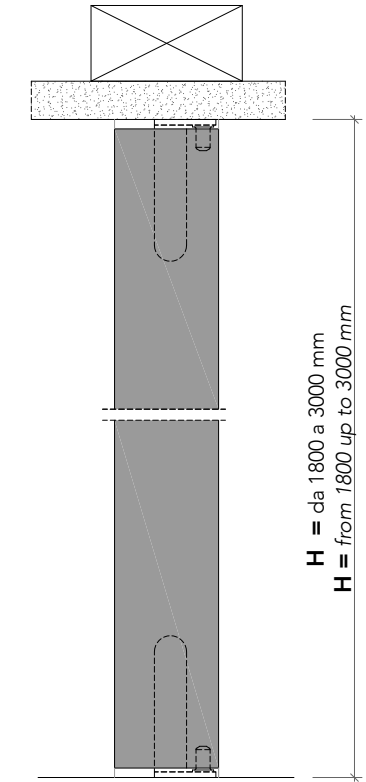

sezione orizzontale ■ horizontal section

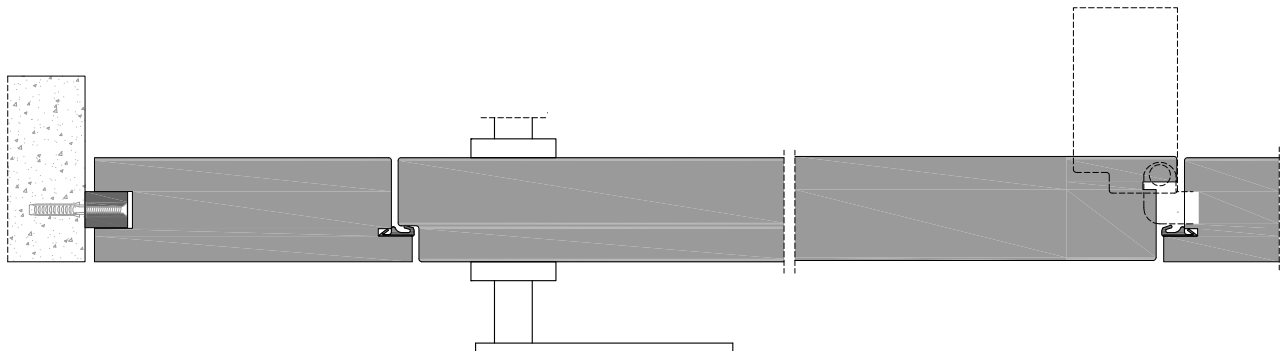
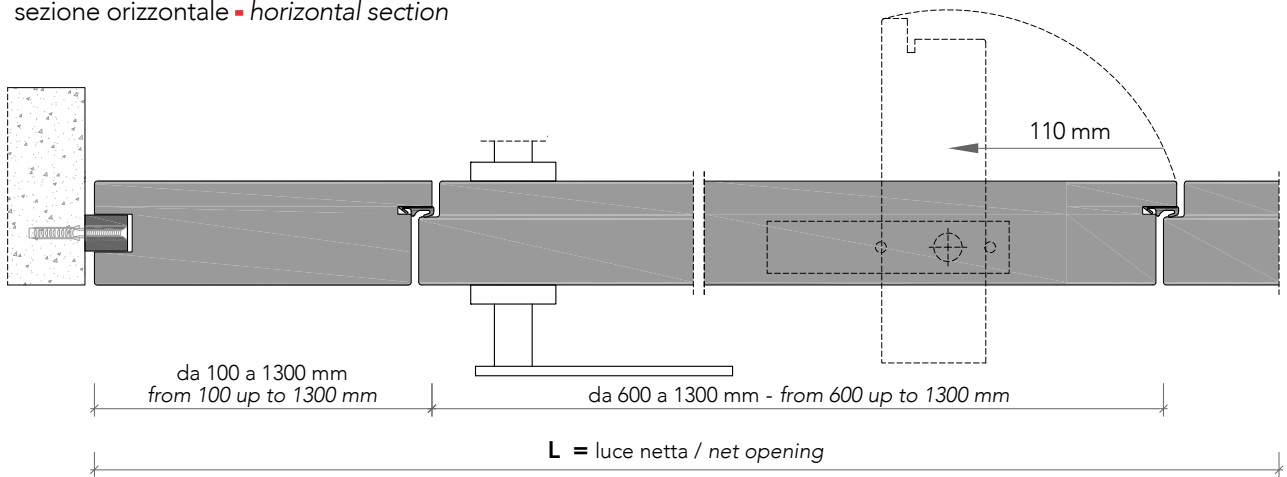

wall&door 55_

spingere destra - push right

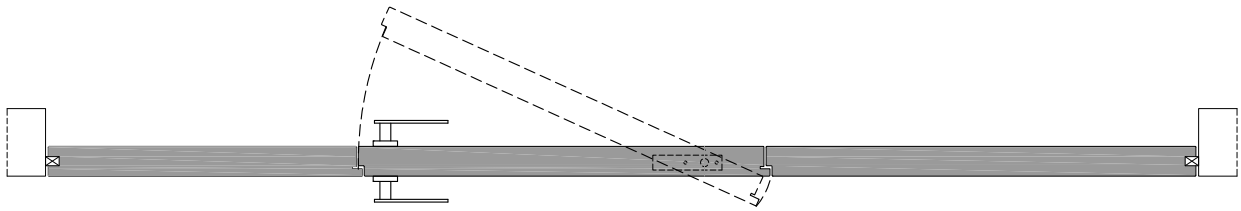

spingere sinistra - push left

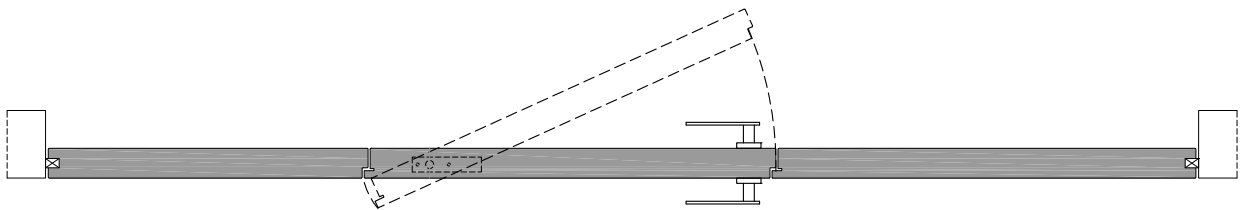

spingere destra - push right

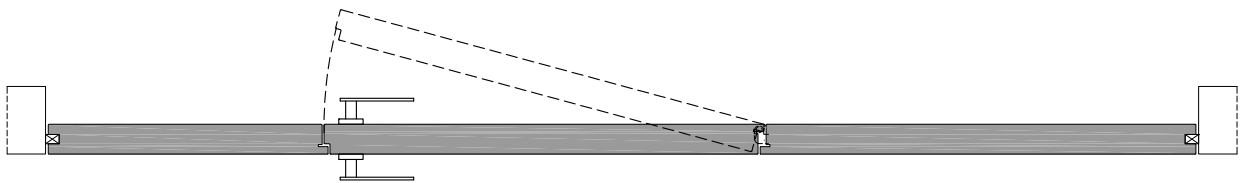

spingere sinistra - push left

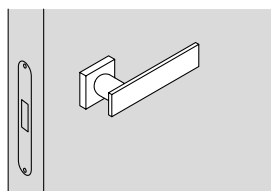
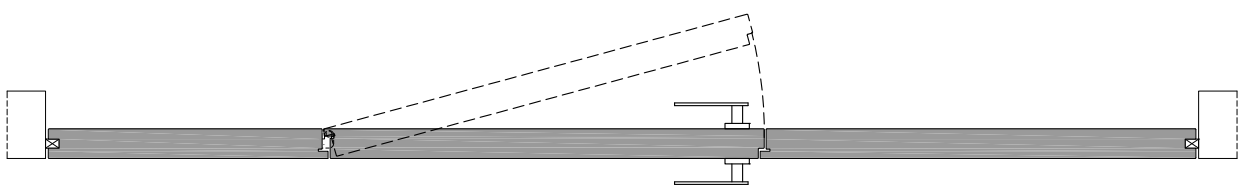

solo maniglia
only passage

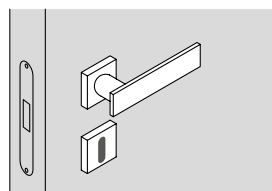

maniglia e chiave
handle and key

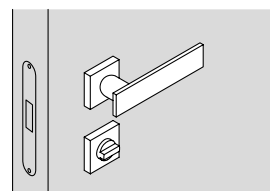

maniglia e nottolino
handle and privacy

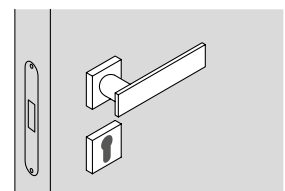

maniglia e cilindro di sicurezza
handle and security cylinder